

Introduction to Software Architecture

17-313 Fall 2022

Administrivia

- **HW3A (planning) due tonight (Sep 29)**
 - **3B (artifacts) due Oct 6**
 - **Make sure to have automated tests!**
 - **3C (reflection) due Oct 13**
- **HW2 presentations this week in recitation**

Learning Goals

- Understand the abstraction level of architectural reasoning
- Appreciate how software systems can be viewed at different abstraction levels
- Distinguish software architecture from (object-oriented) software design
- Use notation and views to describe the architecture suitable to the purpose
- Document architectures clearly, without ambiguity

Views and Abstraction

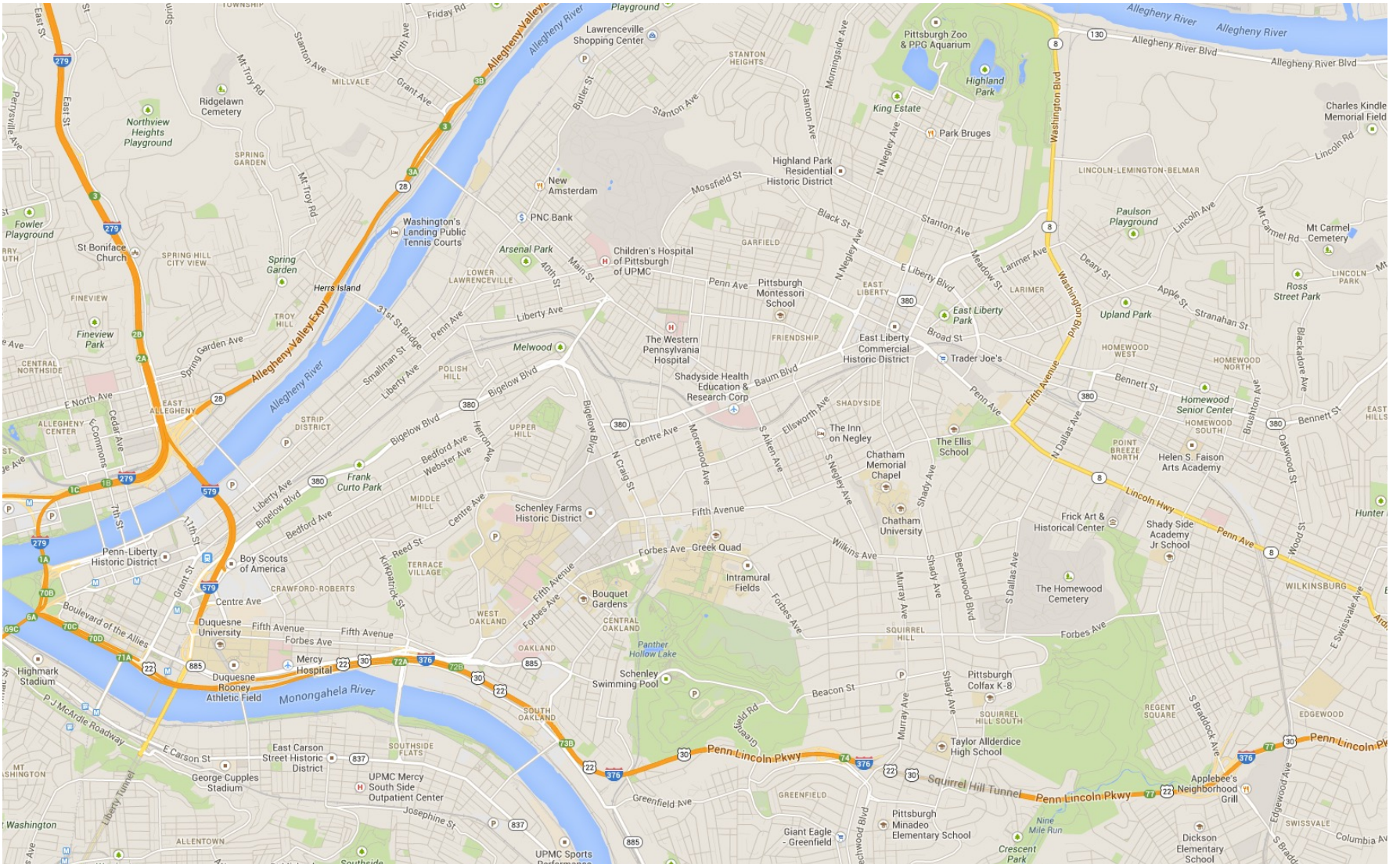

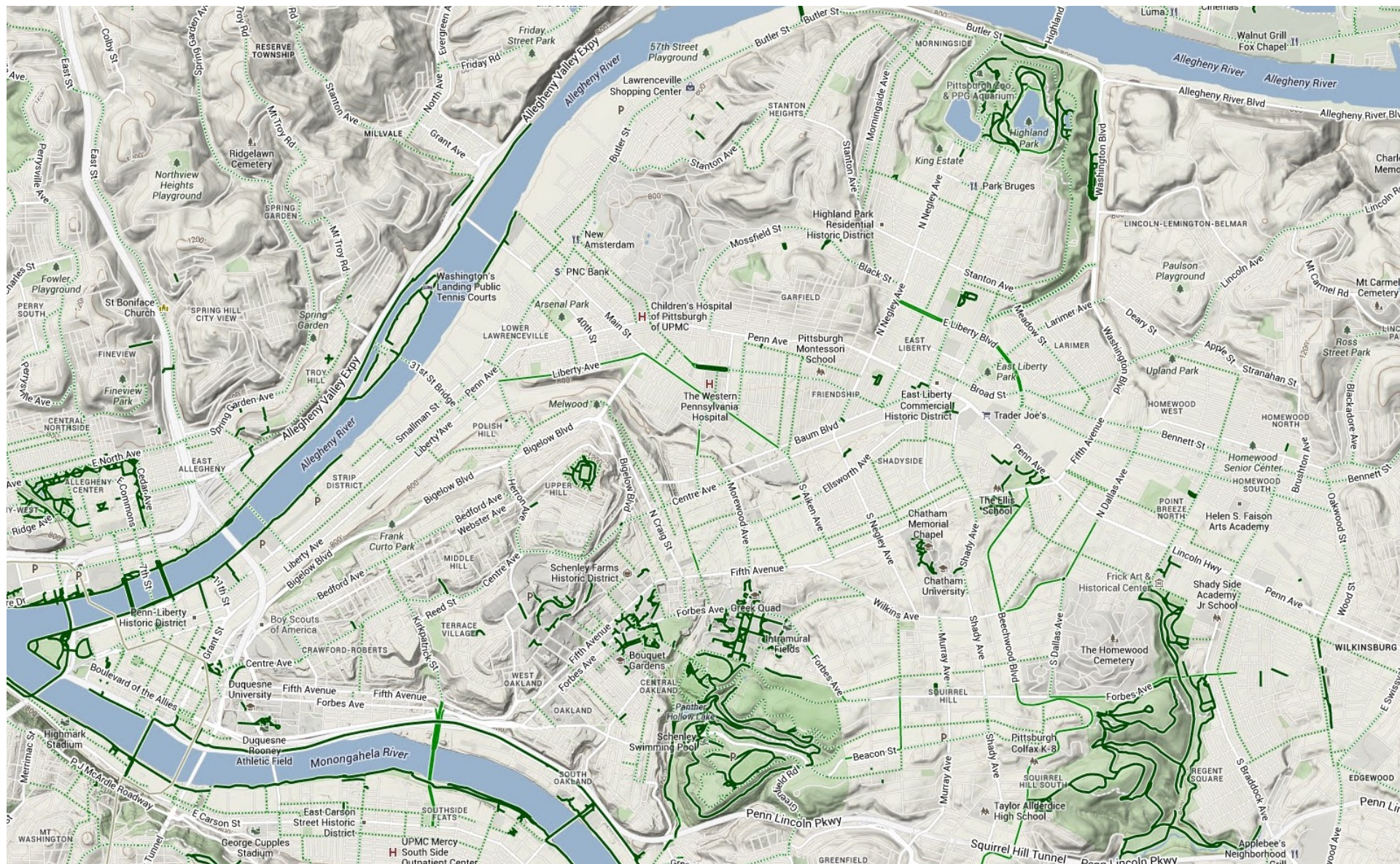

2007 Foreclosure Filing Rate per 100 Mortgaged Units in Allegheny County, PA

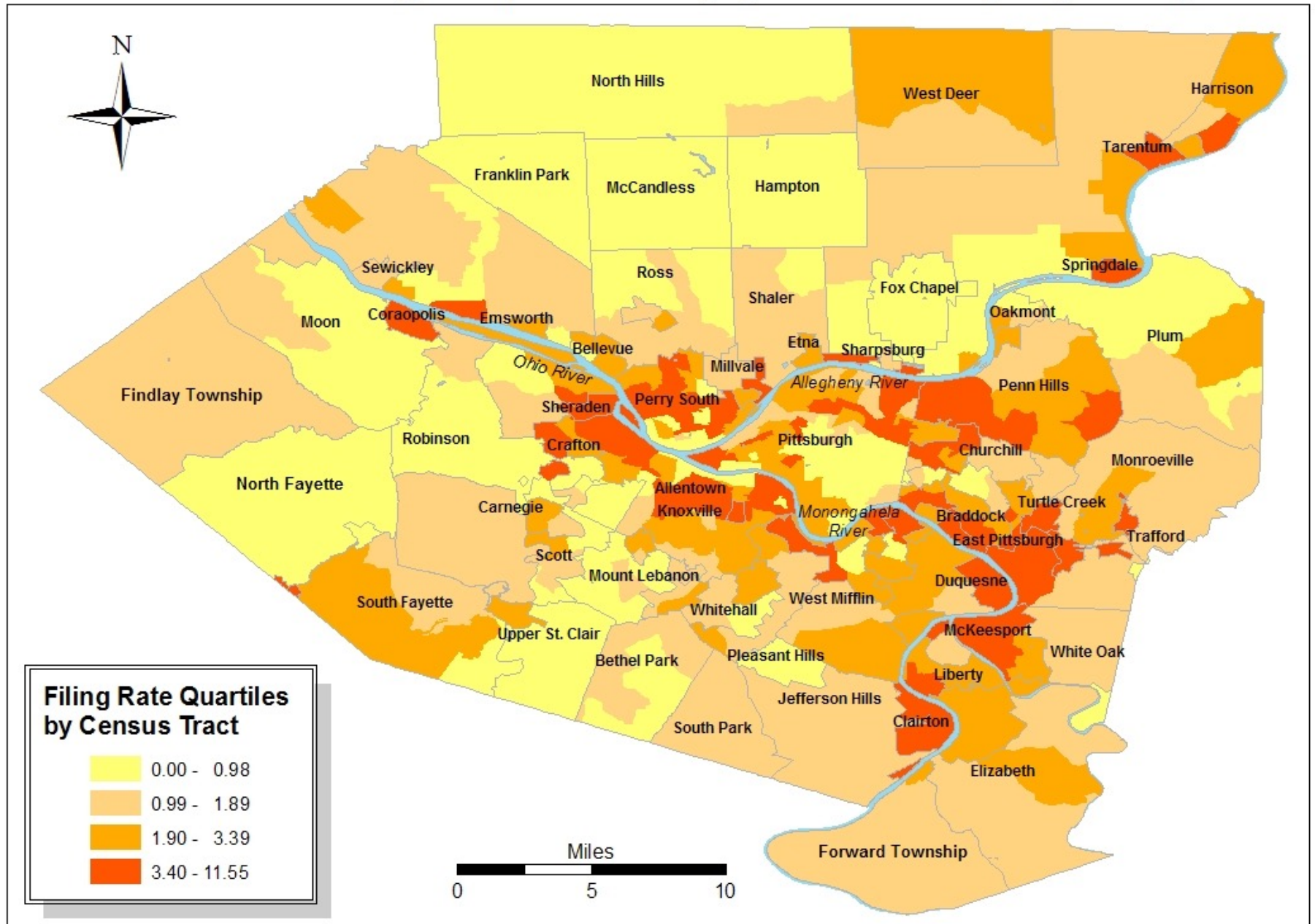

Fire Zones & Firehouses



MAP KEY

Firehouse

- (Engine
-) Engine and Truck
- ★ Truck
- \$ Quint

Fire Zone

- District 1
- District 2
- District 3
- District 4

General fertility rate per 1,000 population by Allegheny County municipality, 2017

Source: <https://www.alleghenycounty.us/>

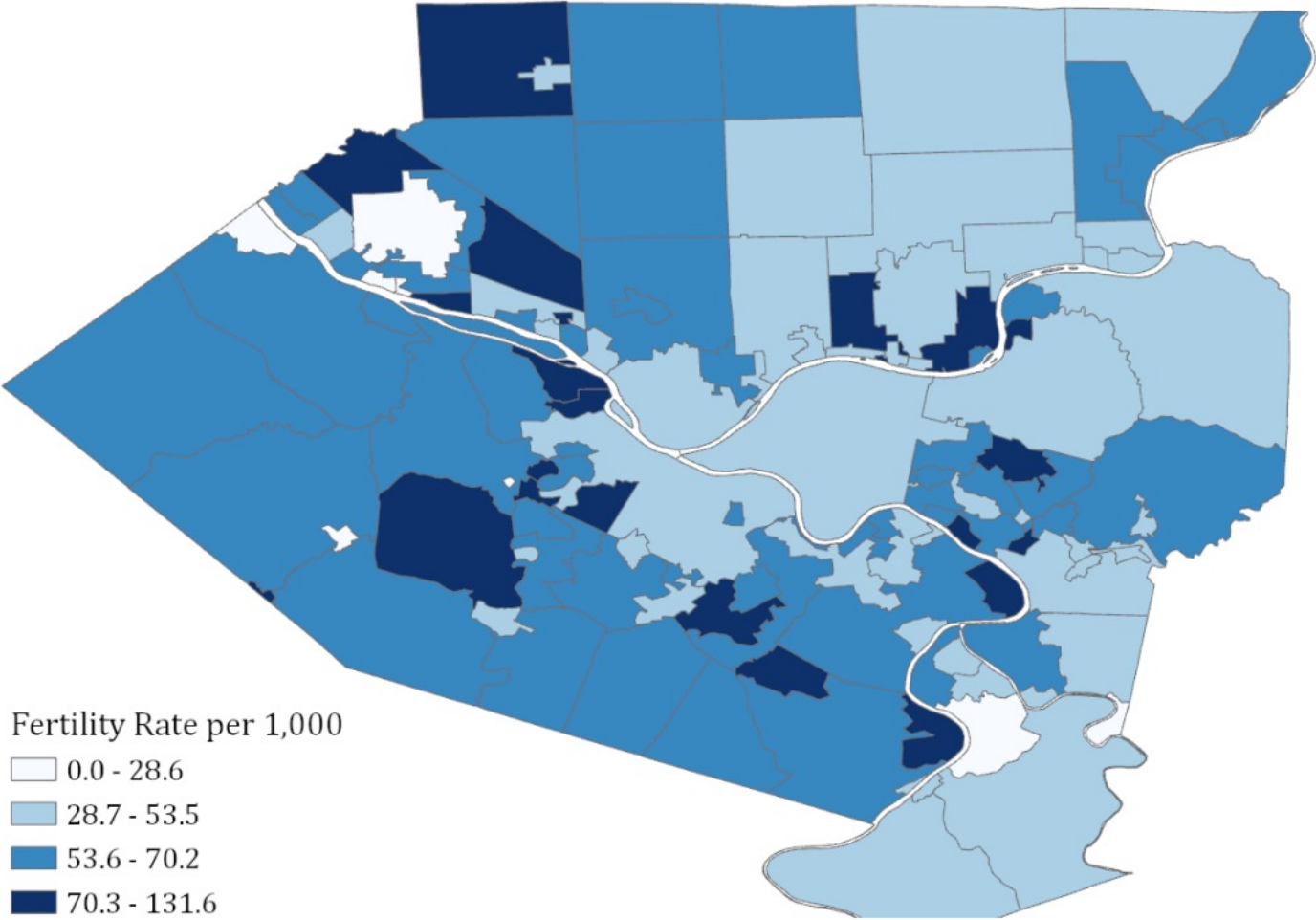

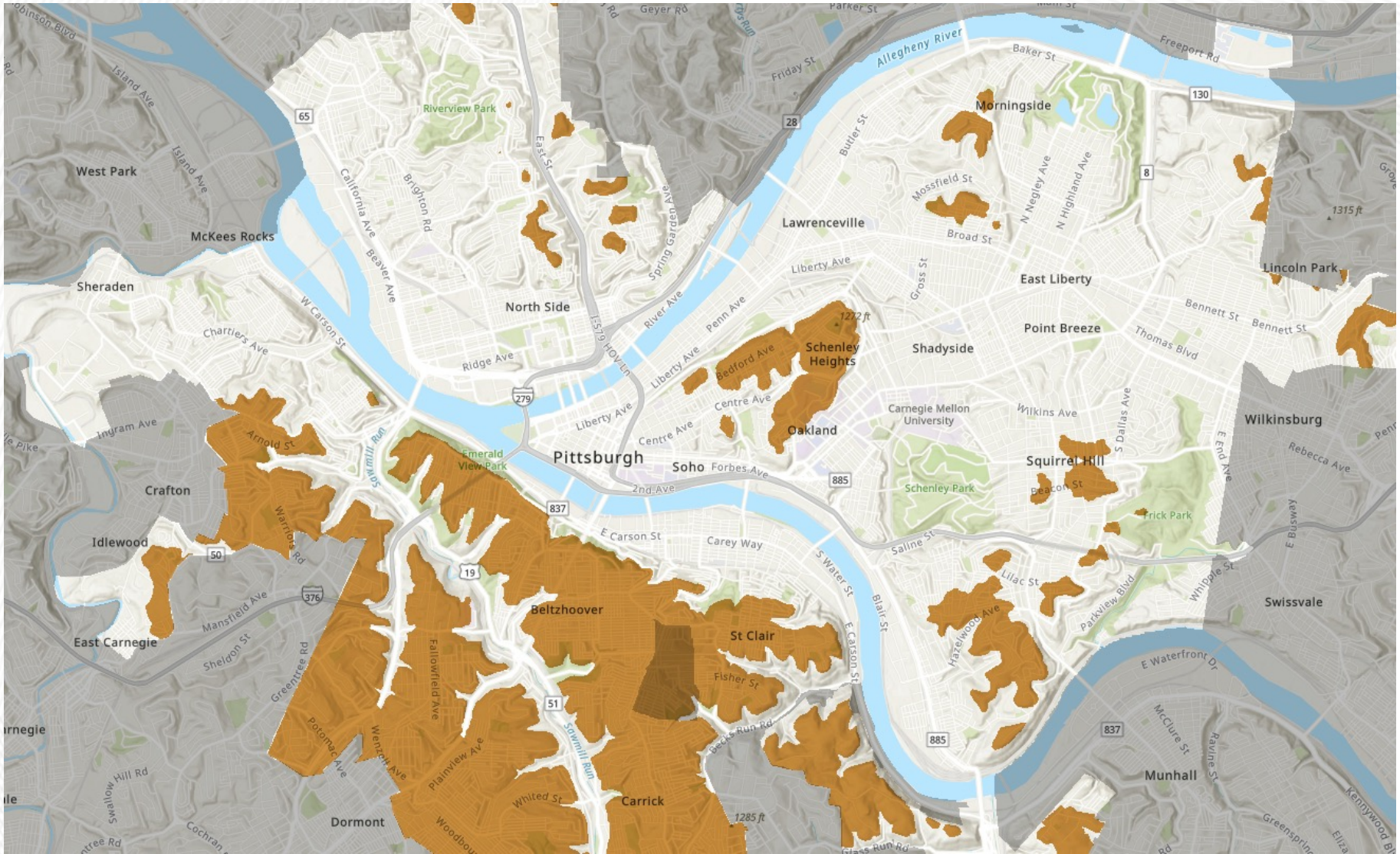

Source: Pittsburgh Zoning Map (<https://gis.pittsburghpa.gov/pghzoning/>)



Abstracted views focus on conveying specific information

- They have a well-defined purpose
- Show only necessary information
- Abstract away unnecessary details
- Use legends/annotations to remove ambiguity
- Multiple views of the same object tell a larger story

Software Architecture



Case Study: Autonomous Vehicle Software

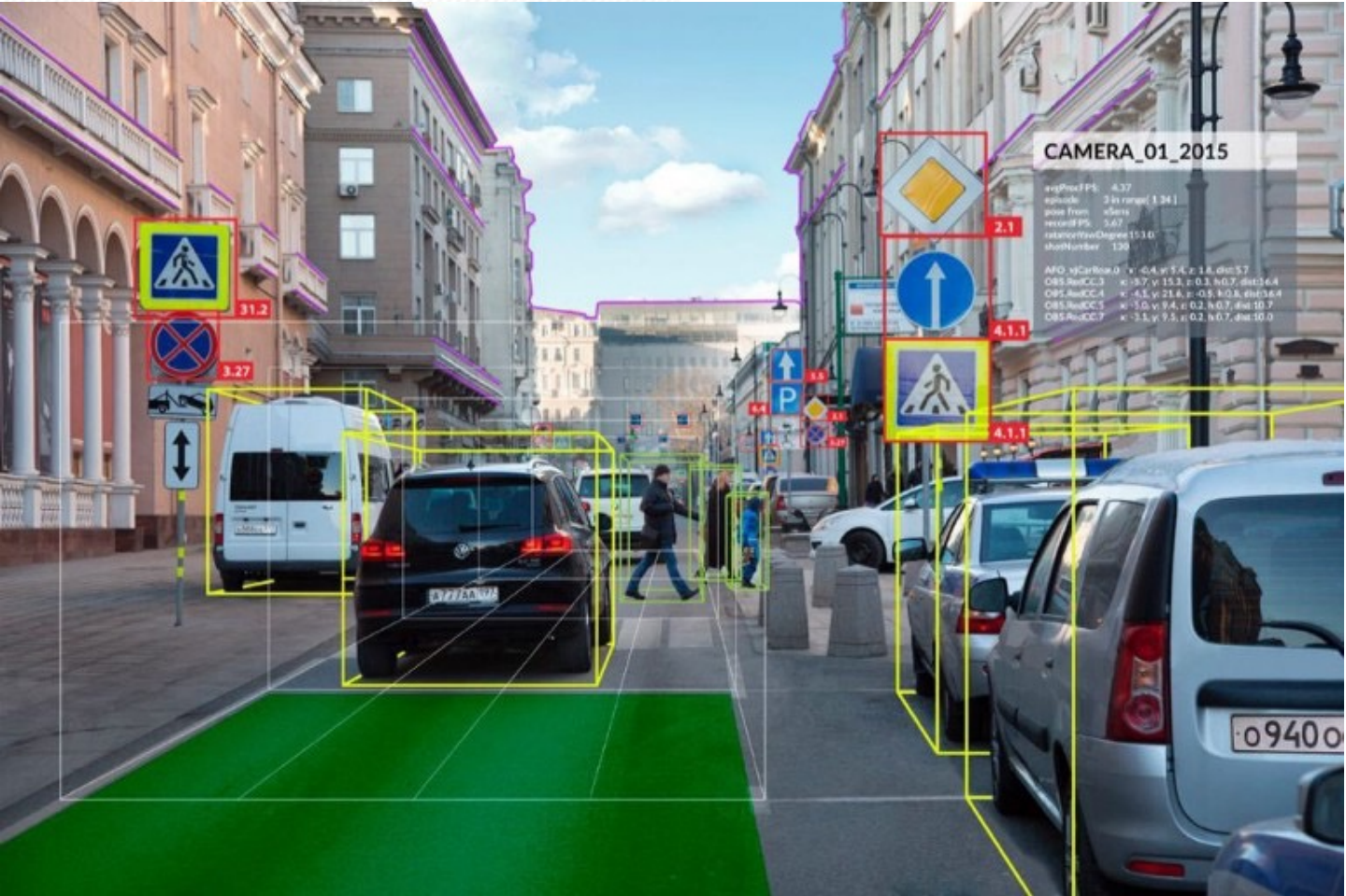

Case Study: Apollo

Check out the “side pass” feature from the video:

<https://www.youtube.com/watch?v=BXNDUtNZdM4>

Source: <https://github.com/ApolloAuto/apollo>

Doxygen: <https://hidetoshi-furukawa.github.io/apollo-doxygen/index.html>

Apollo Software Architecture

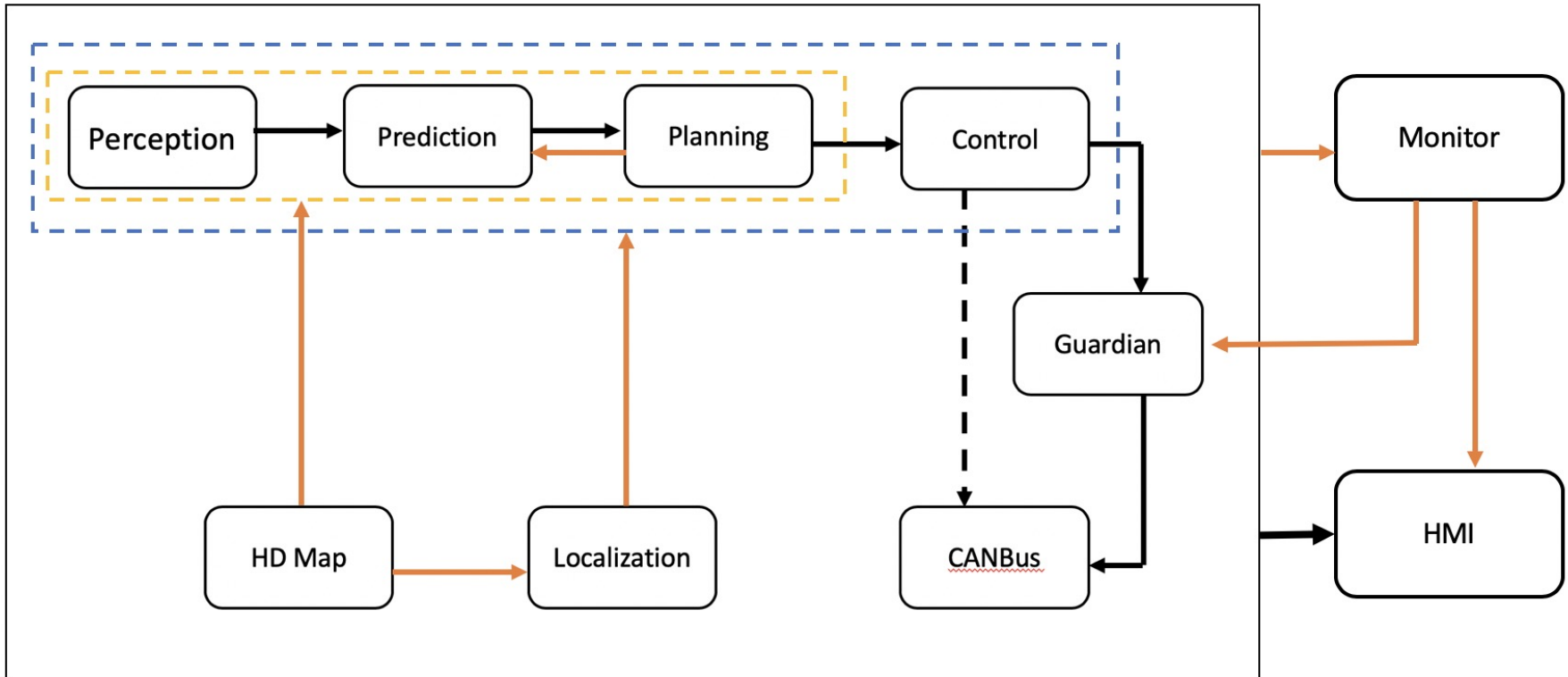

Key:  Data Lines  Control lines

Source: https://github.com/ApolloAuto/apollo/blob/v6.0.0/docs/specs/Apollo_5.5_Software_Architecture.md

Apollo Hardware Architecture

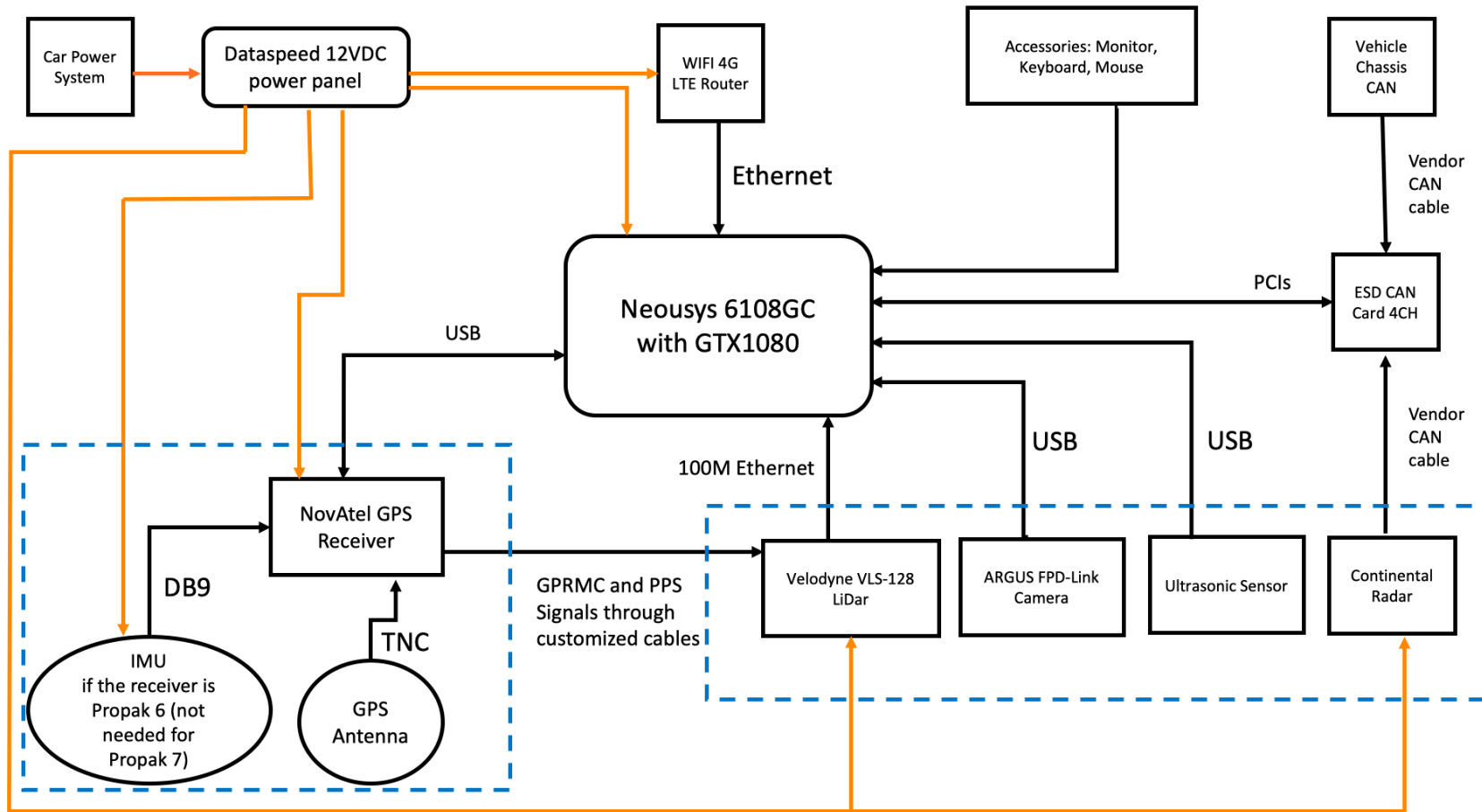

Source: <https://github.com/ApolloAuto/apollo/blob/v6.0.0/README.md>

Apollo Hardware/Vehicle Overview

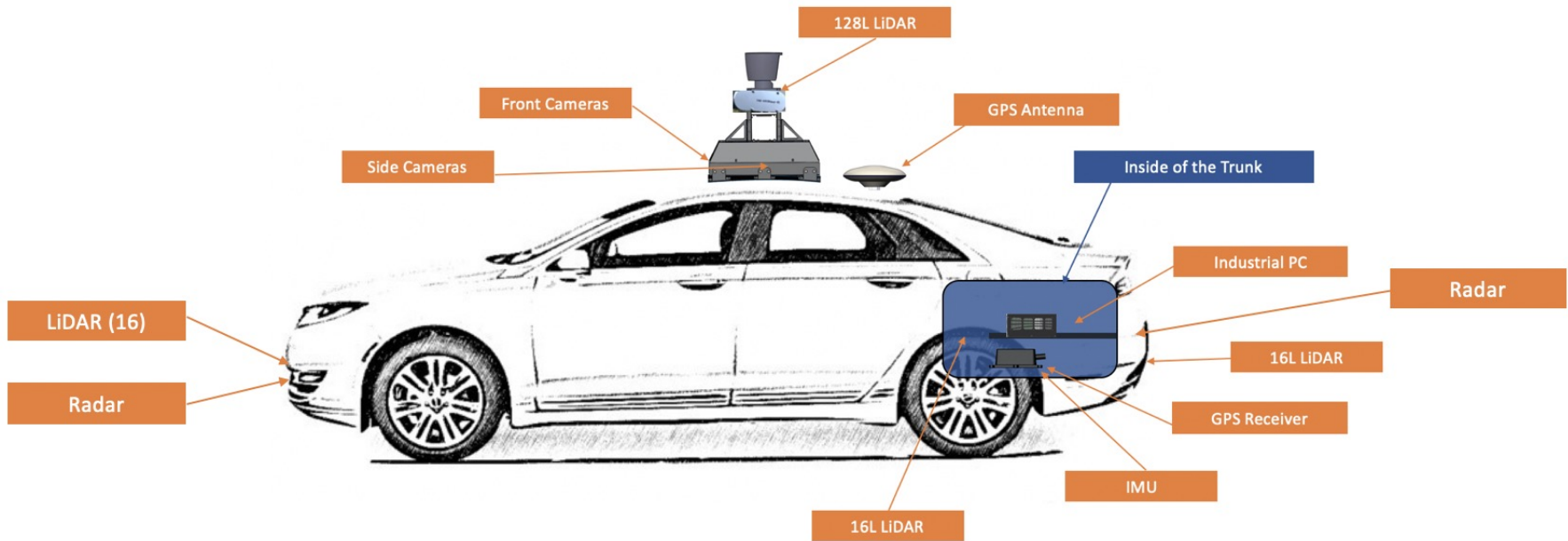

Source: <https://github.com/ApolloAuto/apollo/blob/v6.0.0/README.md>

Apollo Perception Module

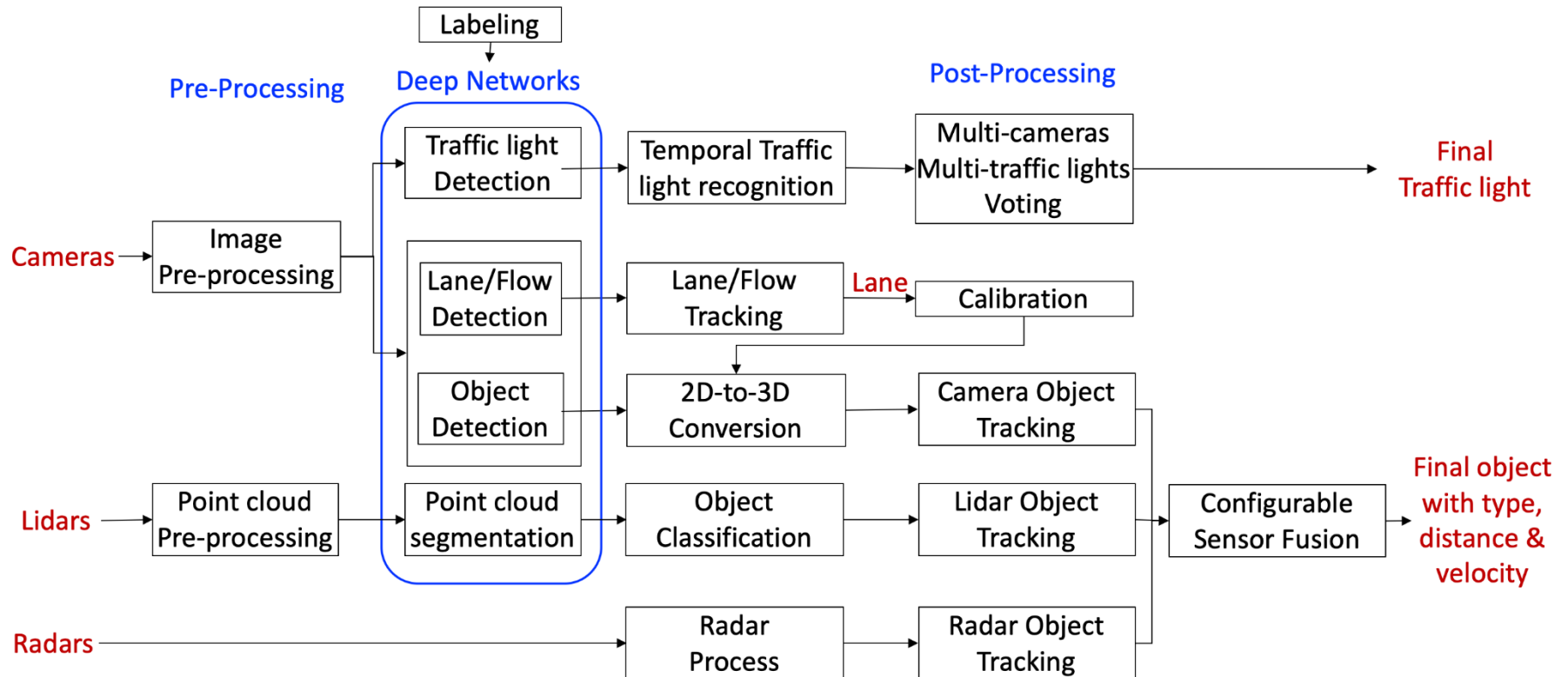

Apollo ML Models

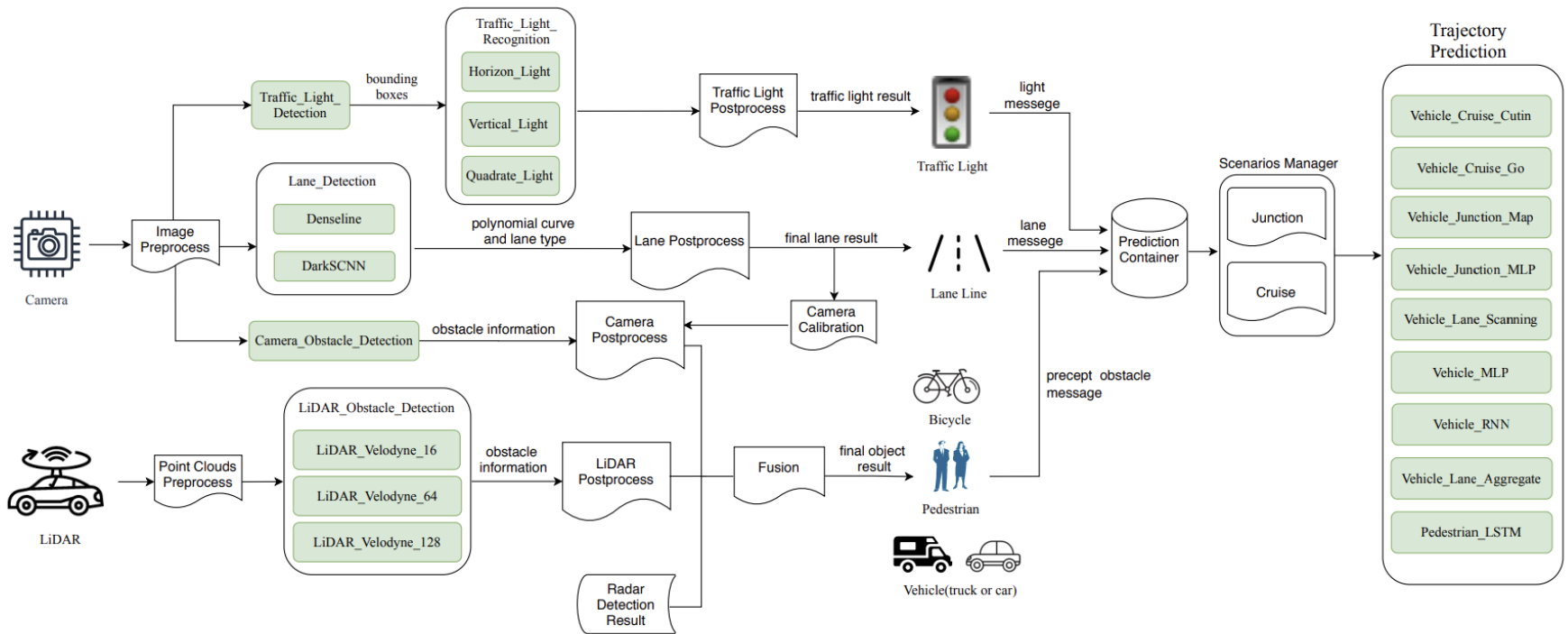

Source: Zi Peng, Jinqiu Yang, Tse-Hsun (Peter) Chen, and Lei Ma. 2020. A First Look at the Integration of Machine Learning Models in Complex Autonomous Driving Systems: A Case Study on Apollo. In Proceedings of the 28th ACM Joint European Software Engineering Conference and Symposium on the Foundations of Software Engineering (ESEC/FSE '20), <https://doi.org/10.1145/3368089.3417063>

Apollo Software Stack

Cloud Service Platform	HD Map	Simulation	Data Platform	Security	OTA	DuerOS	Volume Production Service Components	V2X Roadside Service			
Open Software Platform	Map Engine	Localization	Perception	Planning	Control	End-to-End	HMI	V2X Adapter			
	Apollo Cyber RT Framework										
	RTOS										
Hardware Development Platform	Computing Unit	GPS/IMU	Camera	LiDAR	Radar	Ultrasonic Sensor	HMI Device	Black Box	Apollo Sensor Unit	Apollo Extension Unit	V2X OBU
Open Vehicle Certificate Platform	Certified Apollo Compatible Drive-by-wire Vehicle						Open Vehicle Interface Standard				

Major Updates in Apollo 3.5

Source: <https://github.com/ApolloAuto/>

Feature Evolution (Software Stack View)

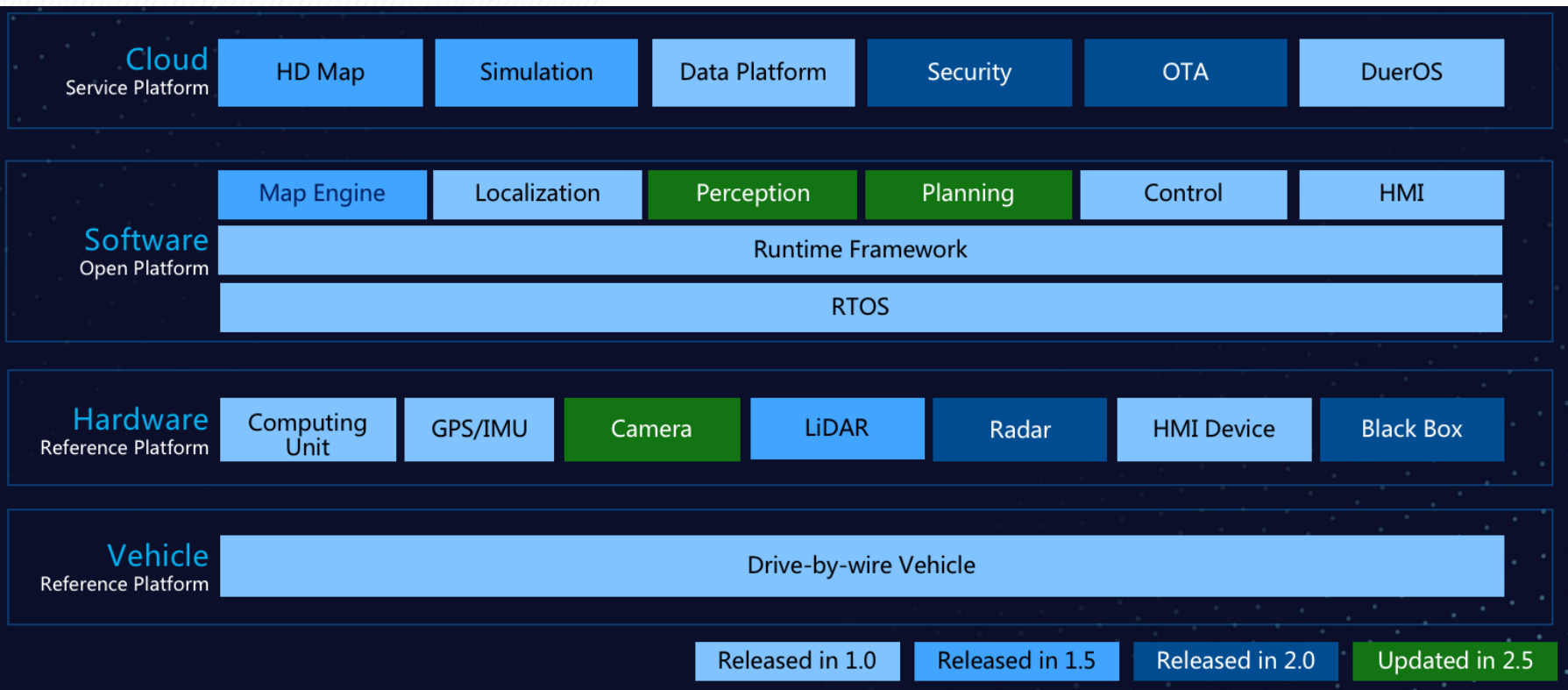

Source: <https://github.com/ApolloAuto/apollo>



Software Architecture

The software architecture of a program or computing system is the structure or structures of the system, which comprise software elements, the externally visible properties of those elements and the relationships among them.

[Bass et al. 2003]

Note: this definition is ambivalent to whether the architecture is known, or whether it's any good!

Software Design vs. Architecture

Levels of Abstraction

- Requirements
 - high-level “what” needs to be done
- Architecture (High-level design)
 - high-level “how”, mid-level “what”
- OO-Design (Low-level design, e.g. design patterns)
 - mid-level “how”, low-level “what”
- Code
 - low-level “how”

Design vs. Architecture

Design Questions

- How do I add a menu item in Eclipse?
- How can I make it easy to add menu items in Eclipse?
- What lock protects this data?
- How does Google rank pages?
- What encoder should I use for secure communication?
- What is the interface between objects?

Architectural Questions

- How do I extend Eclipse with a plugin?
- What threads exist and how do they coordinate?
- How does Google scale to billions of hits per day?
- Where should I put my firewalls?
- What is the interface between subsystems?

Objects

Model

Design Patterns

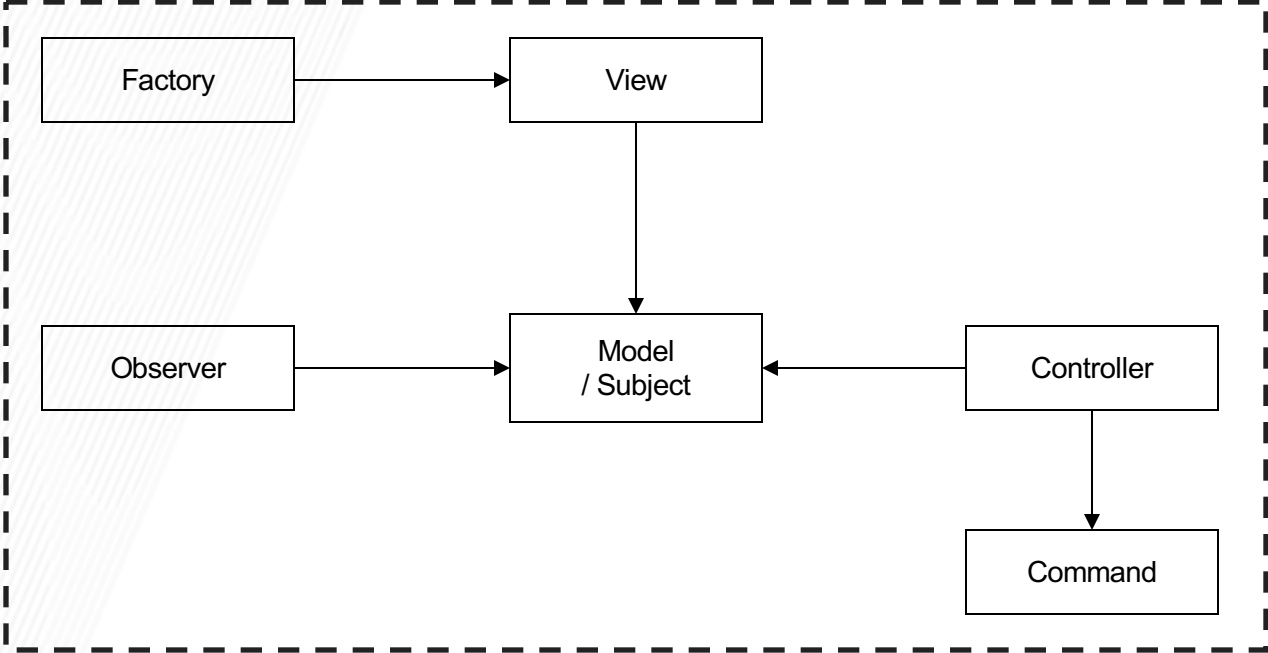

Design Patterns

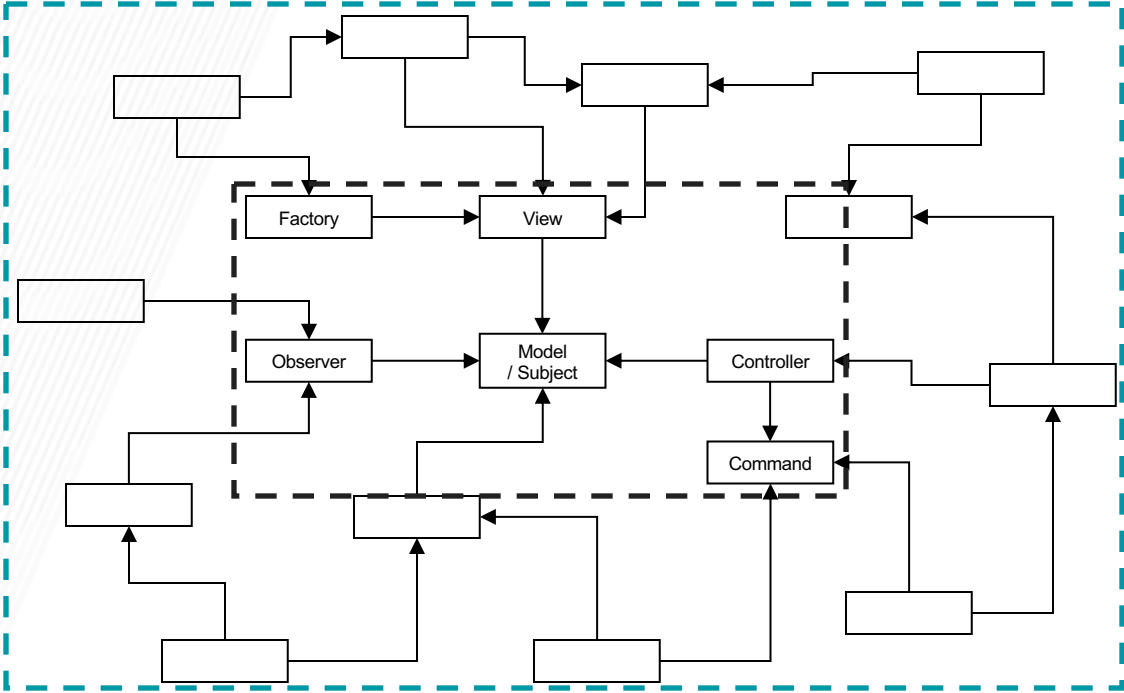

Design Patterns

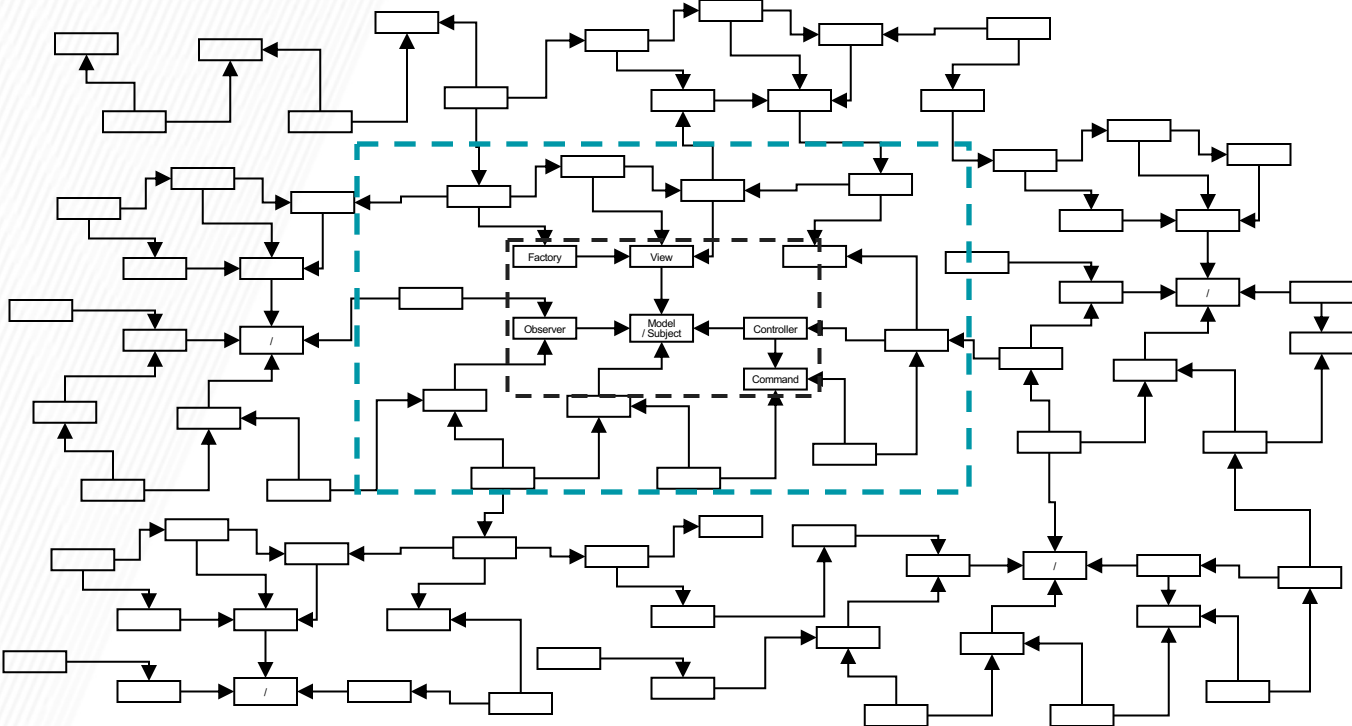

Architecture

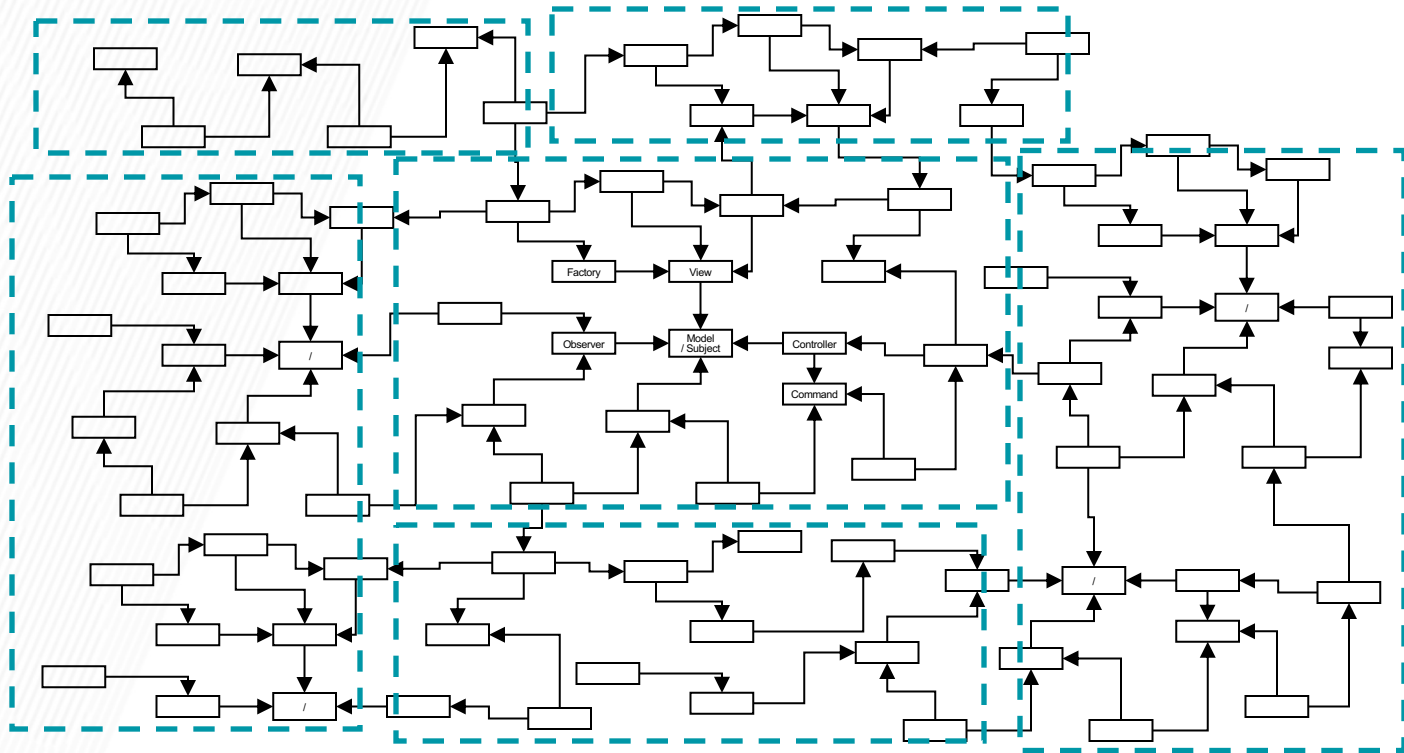

Architecture

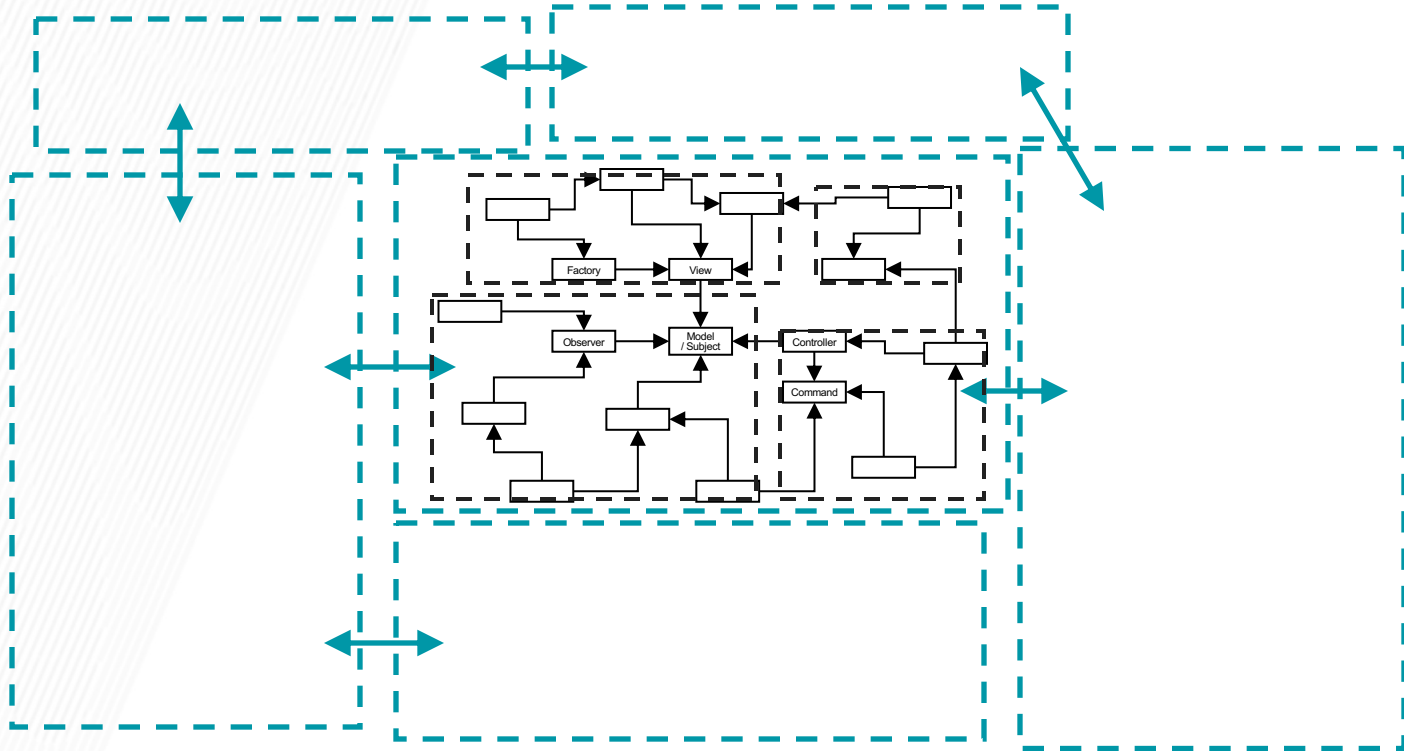

Architecture

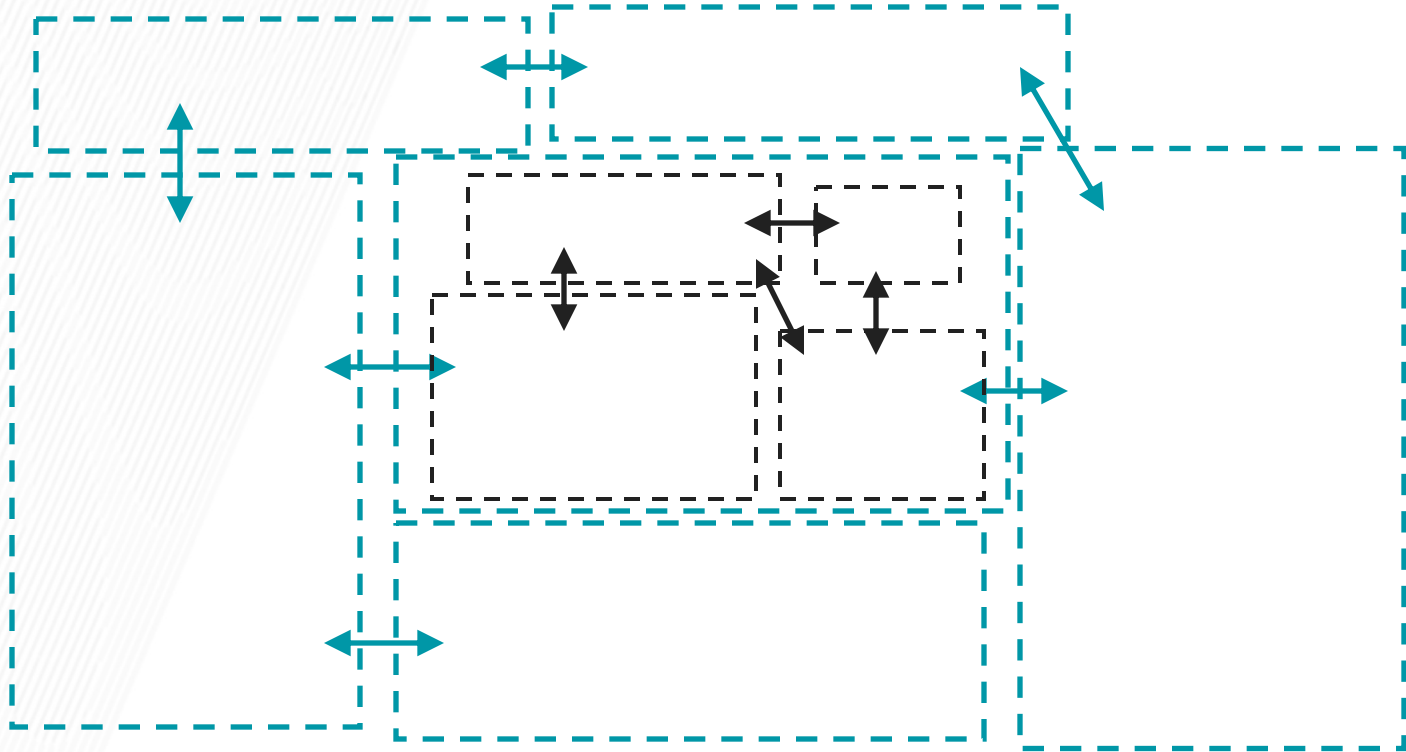

Why Document Architecture?

- Blueprint for the system
 - Artifact for early analysis
 - Primary carrier of quality attributes
 - Key to post-deployment maintenance and enhancement
- Documentation speaks for the architect, today and 20 years from today
 - As long as the system is built, maintained, and evolved according to its documented architecture
- Support traceability.

Views and Purposes

- Every view should align with a purpose
- Views should only represent information relevant to that purpose
 - Abstract away other details
 - Annotate view to guide understanding where needed
- Different views are suitable for different reasoning aspects (different quality goals), e.g.,
 - Performance
 - Extensibility
 - Security
 - Scalability
 - ...

Common Views in Documenting Software Architecture

- **Static View**
 - Modules (subsystems, structures) and their relations (dependencies, ...)
- **Dynamic View**
 - Components (processes, runnable entities) and connectors (messages, data flow, ...)
- **Physical View (Deployment)**
 - Hardware structures and their connections

Common Software Architectures

1. Pipes and Filters

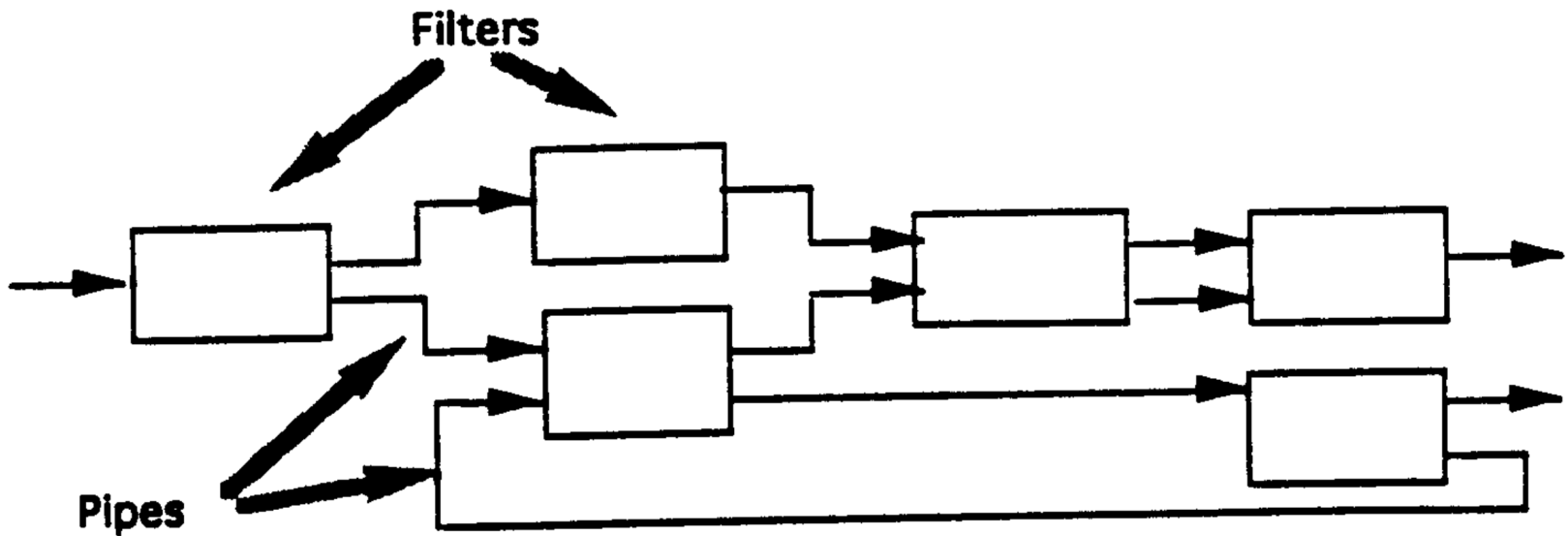

© David Garlan and Mary Shaw, CMU/SEI-94-TR-021

Example: Compilers

```
use M
usage (char *name)
{
    printf("usage %s\n",
        name);
    return 1;
}
int main()
{
    printf("hello\n");
    return 0;
}
```

Language 1 source code

```
public class OddEven {
    private int input;
    public OddEven(int i) {
        input = i;
    }
    public void calculate() {
        if (input % 2 == 0) {
            System.out.println("Even");
        } else {
            System.out.println("Odd");
        }
    }
    public void mainMethod() {
    }
}
```

Language 2 source code

Compiler front-end for language 1

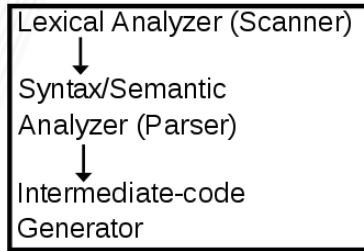

Non-optimized intermediate code

Compiler front-end for language 2

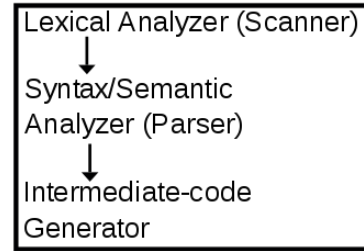

Non-optimized intermediate code

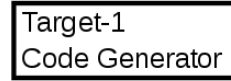
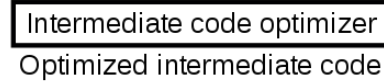

Target-1 machine code

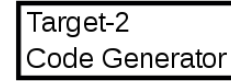

Target-2 machine code



2. Object-Oriented Organization

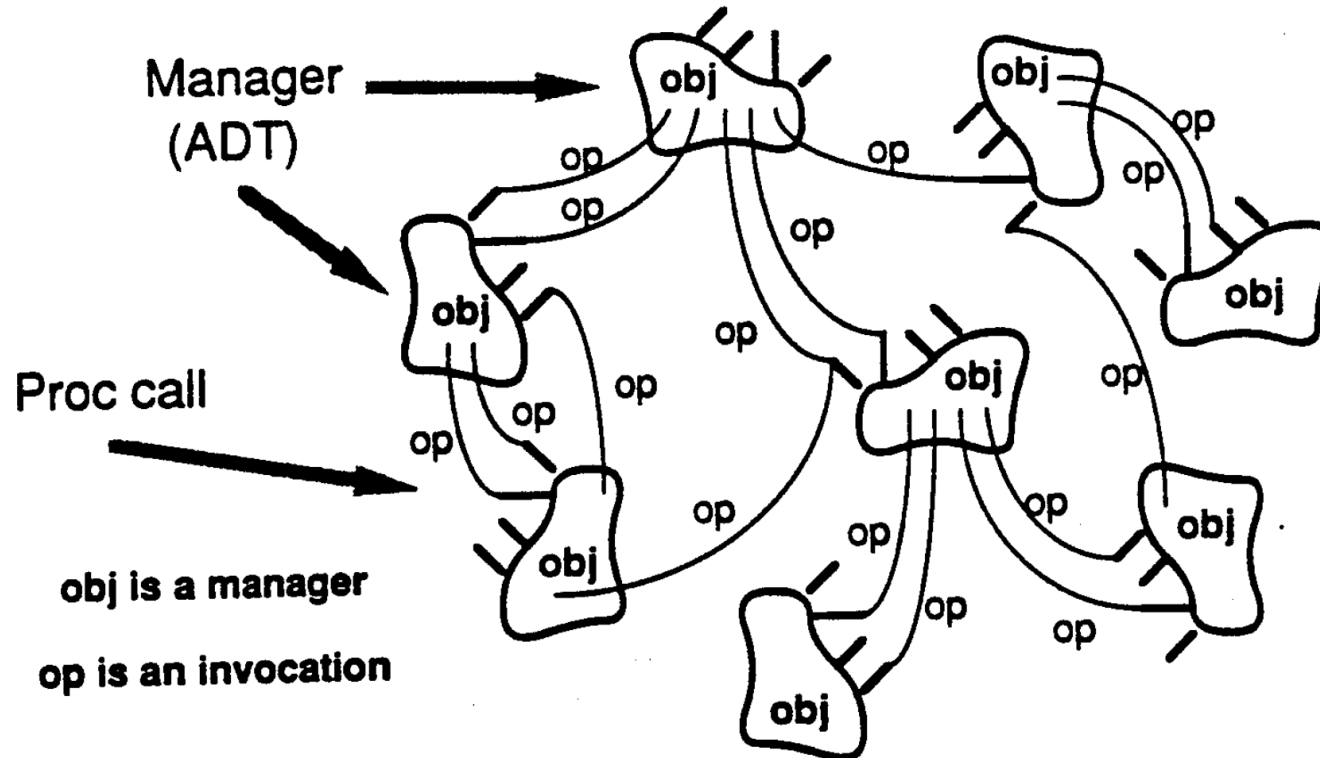

© David Garlan and Mary Shaw, CMU/SEI-94-TR-021

3. Event-Driven Architecture

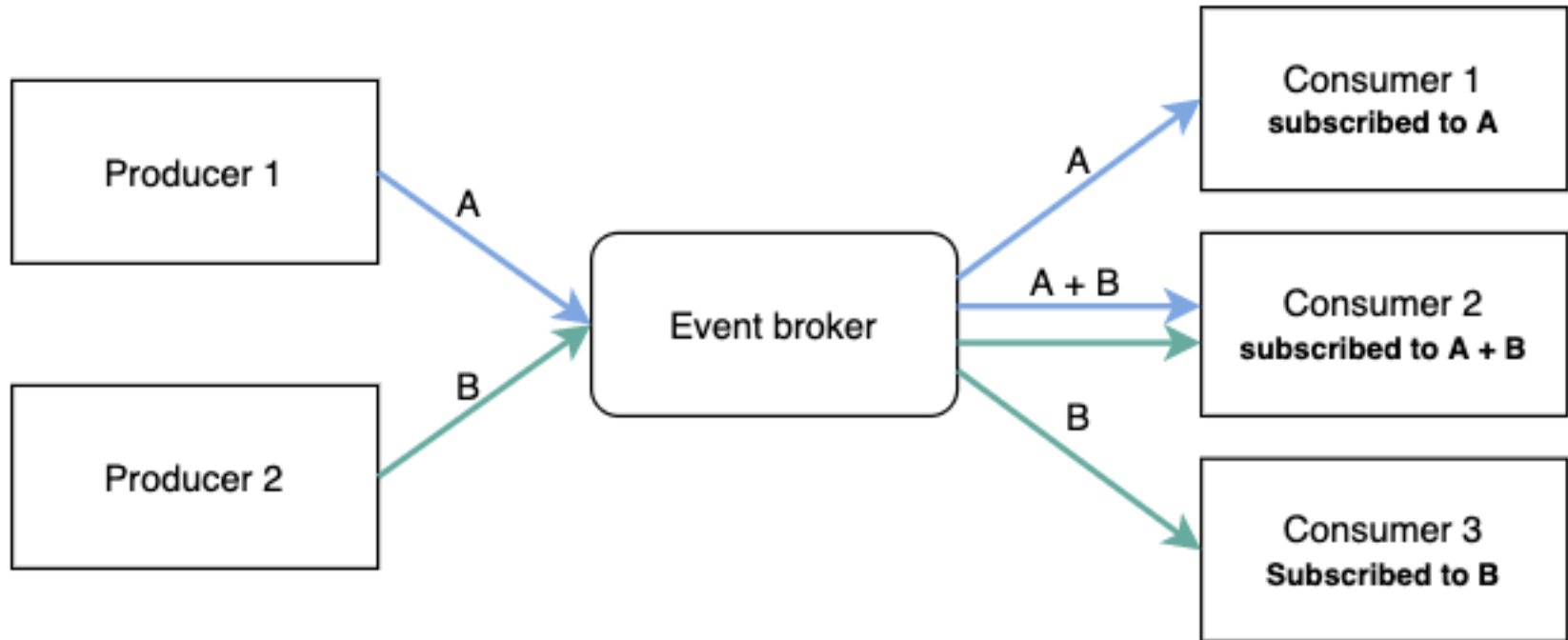

Example: HTML DOM + JavaScript

Commits · CMU-313/Teedy

github.com/CMU-313/Teedy/commits/main

Search or jump to... Pull requests Issues Marketplace Explore

CMU-313 / Teedy Public template

Spons

<> Code Issues 155 Pull requests 149 Discu

main

Commits on Sep 8, 2022

Updated docs-web config to save docs to data/docs directory (#314) **Verified**

ChrisTimperley committed 20 days ago ✓

CMU-313/Teedy on Sep 8

Updated docs-web config to save docs to data/docs directory #314

This ensures that documents are saved to the same place, regardless of platform, and ...

main ← add-fixed-docs-di...

Approved

4. Blackboard Architecture

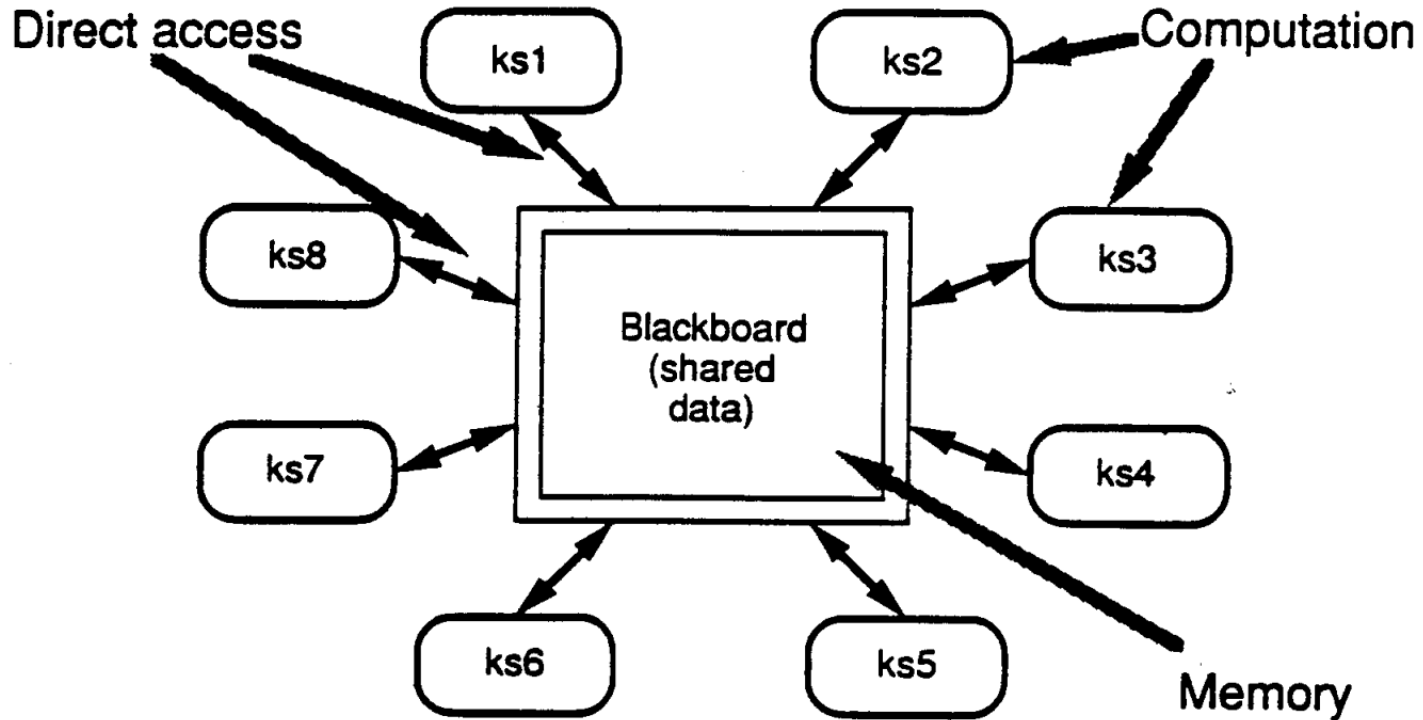

© David Garlan and Mary Shaw, CMU/SEI-94-TR-021

5. Layered Systems

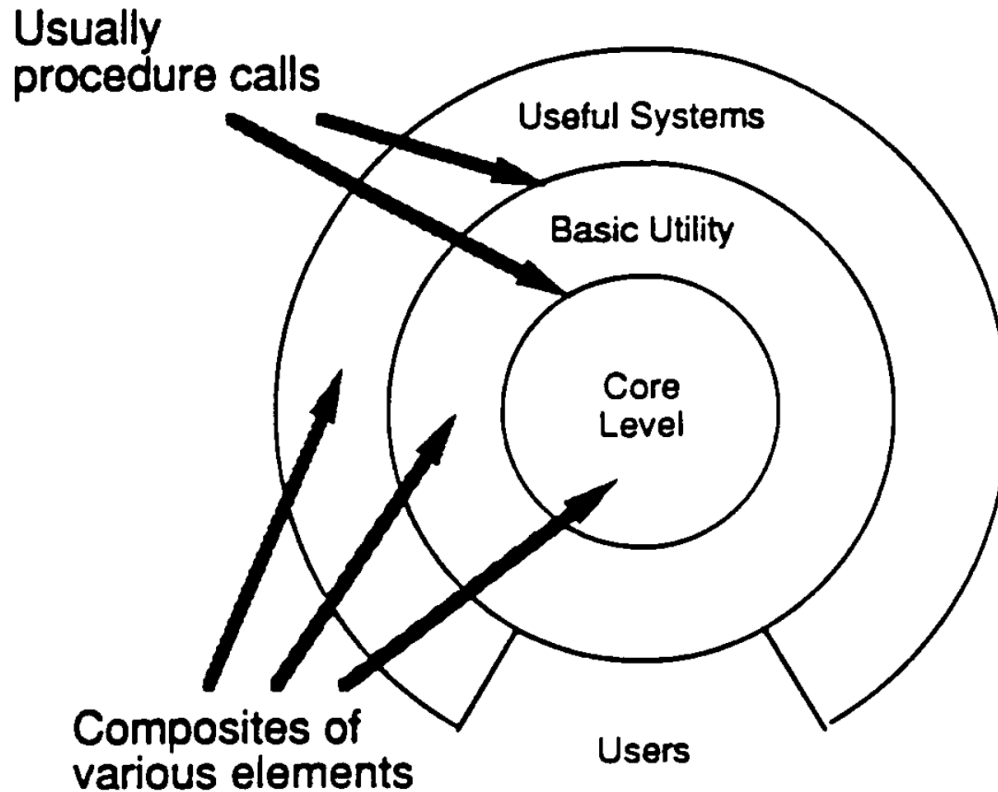

© David Garlan and Mary Shaw, CMU/SEI-94-TR-021

Example: Internet Protocol Suite

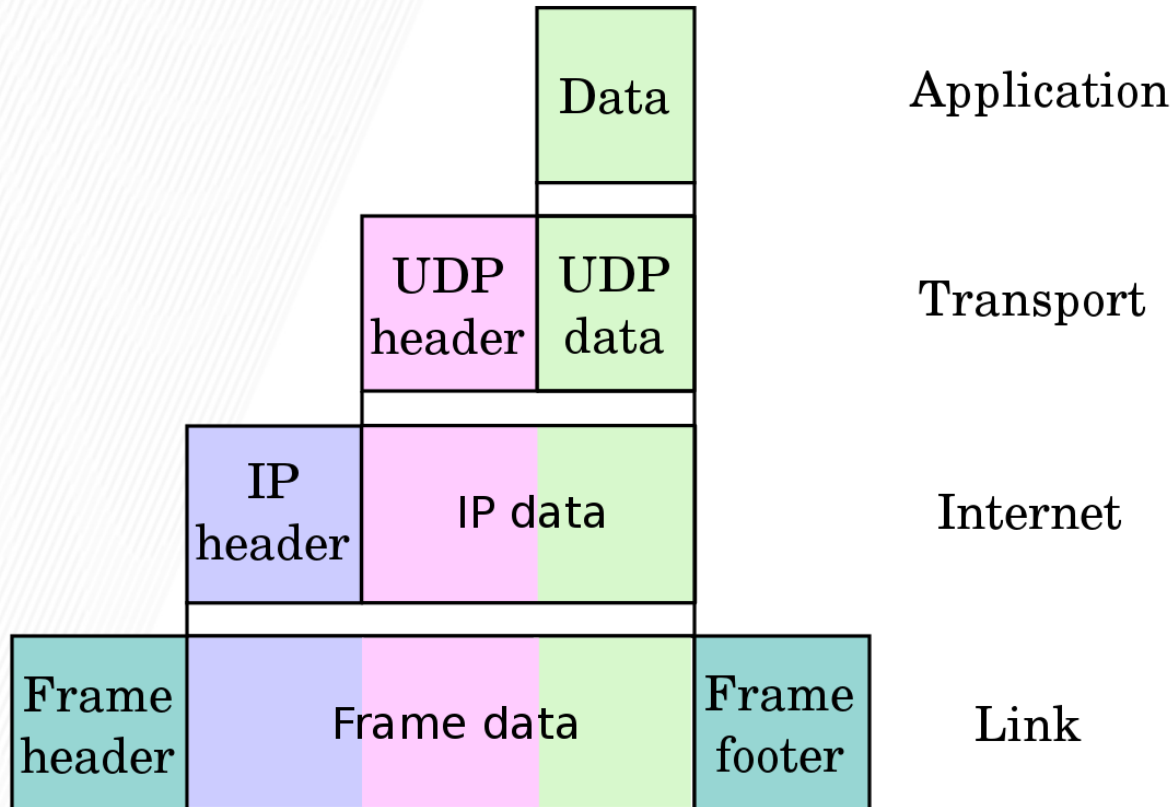

Guidelines for selecting a notation

- Suitable for purpose
- Often visual for compact representation
- Usually boxes and arrows
- UML possible (semi-formal), but possibly constraining
 - Note the different abstraction level – Subsystems or processes, not classes or objects
- Formal notations available
- Decompose diagrams hierarchically and in views
- Always include a legend
- Define precisely what the boxes mean
- Define precisely what the lines mean
- Do not try to do too much in one diagram
 - Each view of architecture should fit on a page
 - Use hierarchy

Next Up

- Microservices